

Info
1 Cuartos de vuelta
2 Control de varillas
3 Sistemas de cierre
4 Bisagras
5 Juntas
6 Asas
7 Ventanas
8 Acero inox
9 Cierres de tracción
10 Climatización
11 Sistemas de cierre electrónico
12 Varios



Cabeza pequeña =
DIN ISO 2009, 2010,
7046-1, 7046-2, 7047

* No incluido en la entrega

Otros componentes ver página
- Llaves 12B-120



IP 65 con junta

Cierre de lengüeta

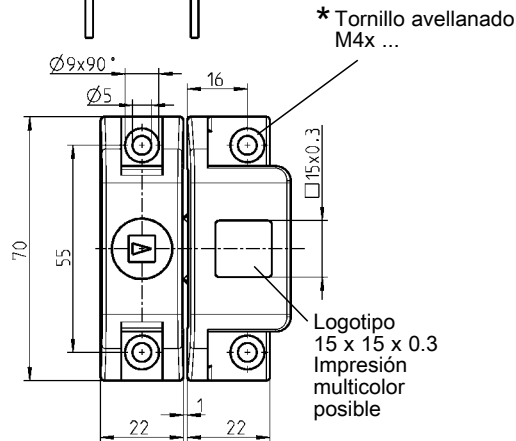
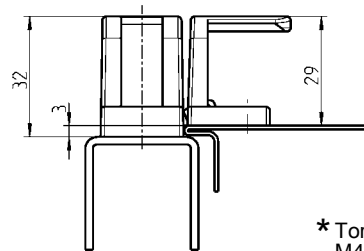
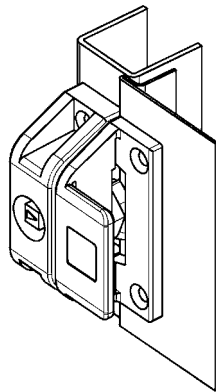

Cierre de lengüeta en poliamida negra, inserto en zamak cromado, lengüeta, tornillo y arandela elástica en acero cincado

Cuadradillo 7	1076-U5	Doble barra 3	1076-U9
Cuadradillo 8	1076-U6	Doble barra 5	1076-U10
Triángulo 7	1076-U7	Allen hexagonal SW 10	1076-U11
Triángulo 8	1076-U8	Ranura 2 x 4	1076-U12

Cierre de resorte sin y con junta

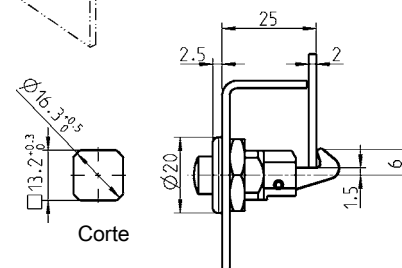
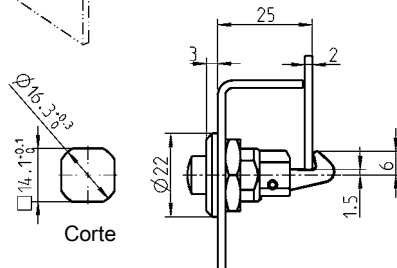
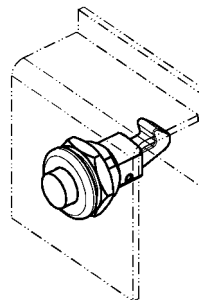
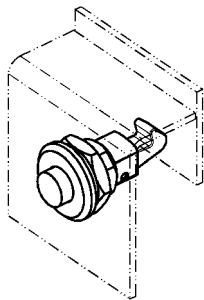

Versión A

Versión B

Cierre de resorte en zamak cromado, con o sin junta

Versión A		Versión B	
sin junta	1047-U3	sin junta	1047-U2
con junta IP 65	1047-U5	con junta IP 65	1047-U4