

# FICHA DEL PRODUCTO

ITEM:

Terminal desnudo estañado 6AWG (16mm<sup>2</sup>) perf 7.0mm

CÓDIGO:

35090006AK

IMAGEN:



DESCRIPCIÓN  
APLICACIÓN:

Fabricado en cobre ETP  
Acabado: estañado galvánico

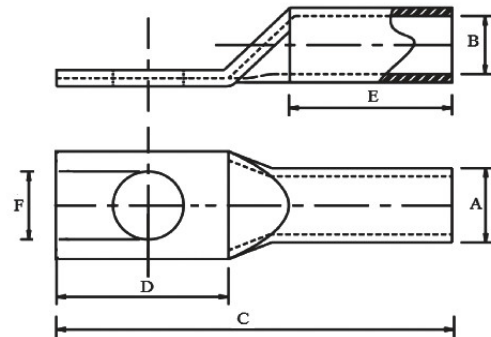

GAUGE AWG	Stud Size F	A mm	B mm	C mm	D mm	E mm
8 AWG	5.0mm	6.5	4.5	33	17	13
6 AWG	7.0mm	7.5	5	37	18	16
4 AWG	7.0mm	8.6	6.2	40	18	17
3 AWG	8.5mm	9.5	7.3	41	19	18
2 AWG	8.5mm	10.5	7.8	43	20	18
1 AWG	8.5mm	11.7	9.1	43	20	18
1/0 AWG	8.5mm	13	10	46	20	19
2/0 AWG	10.5mm	14.2	11.2	47	20	19
3/0 AWG	10.5mm	15.7	12.7	50	20	22
4/0 AWG	13.5mm	17.4	13.9	60	27	25
250AWG	13.5mm	19	15.1	63	27	28
300AWG	13.5mm	20.6	16.5	65	27	30
350AWG	13.5mm	22	17.8	65	27	30
400AWG	13.5mm	25	19.5	70	27	32
500AWG	13.5mm	26	21.2	77	30	35
600AWG	13.5mm	30	23.6	90	38	38
700AWG	13.5mm	31.7	25.4	110	47	46
750AWG	13.5mm	33	26.2	114	49	48
800AWG	13.5mm	33.5	27	118	50	50
1000AWG	13.5mm	36.5	30.2	126	52	48