



SOLUCIONES ELECTRICAS

WWW.NDU.CL



CATALOGO RESUMIDO EMKA 2018

HERRAJES PARA TABLEROS METALICOS



ORIGEN: ALEMANIA



CIERRES PARA TABLEROS METALICOS

Cierres IP65, Con perforaciones desde 14,1 hasta 20,1 mm

Minicierres IP65, perforacion 14.1mm, fijacion con tuerca

CODIGO	DESCRIPCION	
493804EK	Mini cierre, con llave, metal cromado, c/leng H=13,5mm.	
493812EK	Mini cierre, con llave, poliamida negra, c/leng H=13,5mm	
493809EK	Mini cierre, sin llave, metal, paleta negra, c/leng H=13,5mm	
493810EK	Mini cierre, con llave, metal, paleta negra, c/leng H=13,5mm	
493802EK	Mini cierre, sin llave, metal, paleta negra T /32mm, c/leng H=13,5mm	
493803EK	Mini cierre, con llave, metal, paleta negra T /32mm, c/leng H=13,5mm	
494022EK	Mini cierre, con botón con traba diam.22mm, metal cromado,	

MINICIERRES IP65, PERFOR.17,8mm, FIJ. C/CLIP, EMKA – ALEMANIA

CODIGO	DESCRIPCION	
493801EK	Mini cierre, con llave, metal cromado, c/lengüeta H=13,5mm	
493805EK	Mini cierre, monedero, poliamida negra, c/leng H=13,5mm	
493806EK	Mini cierre, con paleta redonda, poliam.negra, c/leng H=19,5mm	
493811EK	Accesorio lengüeta para mini cierres H=19.5mm.	
491386EK	Accesorio Tirador poliamida para mini cierres c/perforación 14.1mm	

CIERRES IP65, PERFOR. 20,1mm, FIJ. C/CLIP, EMKA – ALEMANIA

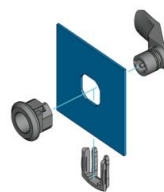
CODIGO	DESCRIPCION	
490715EK	Cierre monedero poliamida c/traba presión perf 20.5mm H18mm	
490702EK	Cierre triangulo poliamida c/traba presión perf 20.5mm H18mm	

CIERRES IP65, PERFOR. 20,1mm, FIJ. C/ TUERCA, EMKA – ALEMANIA

CODIGO	DESCRIPCION	
490105EK	Cierre monedero metal negro, cuerpo metal cromado, acción. color negro, H=18mm c/leng. acero	
493905EK	Cierre monedero cromado, cuerpo metal negro, acción. cromado, H=18mm c/leng. Acero	
490926EK	Cierre monedero, poliamida, H=18mm c/leng. Acero	
490905EK	Cierre monedero, poliamida, H=18mm c/lengüeta poliamida	
490104EK	Cierre universal, metal cromado, H=18mm c/lengüeta metálica	
490917EK	Cierre universal, poliamida, H=18mm c/lengüeta poliamida	
490102EK	Cierre triangulo negro, cuerpo metal cromado, H=18mm c/lengüeta acero	
493902EK	Cierre triangulo cromado, cuerpo metal negro, H=18mm c/lengüeta acero	
490927EK	Cierre triangulo, poliamida H=18mm c/leng. acero	
490902EK	Cierre triangulo, poliamida H=18mm, c/lengüeta poliamida	
490929EK	Cierre cuadrado, poliamida H=18mm c/leng. Acero	

CIERRES CON LLAVE, IP65, PERFOR. 20,1mm, FIJ. C/ TUERCA, EMKA – ALEMANIA

CODIGO	DESCRIPCION	
490101EK	Cierre con llave, Diam.32mm, cuerpo metal cromado, H=18mm c/lengüeta acero.	
493901EK	Cierre con llave, Diam.28mm, cuerpo metal cromado, H=18mm c/lengüeta acero.	
490901EK	Cierre con llave, cuerpo poliamida, H=18mm c/lengüeta poliamida	

CIERRES P/ PARED GRUESA, IP65, PERFOR. 20,1mm, FIJ. C/ TUERCA, EMKA - ALEMANIA

CODIGO	DESCRIPCION	
494006EK	Cierre Monedero, metal cromado, c/ adaptador H=40mm c/lengüeta acero	
494005EK	Cierre Triangulo, metal cromado, c/ adaptador H=40mm c/lengüeta acero	

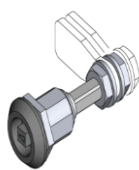

CIERRES ANTIVIBRATORIO, IP65, PERFOR. 20,1mm, FIJ. C/ TUERCA, EMKA - ALEMANIA



CODIGO	DESCRIPCION	
490402EK	Cierre triangulo anti vibratorio metal negro, cuerpo metal negro, H=31+6mm, Sin lengüeta	
493903EK	Cierre triangulo anti vibratorio metal negro, cuerpo metal negro H=31+6mm con lengüeta	
490401EK	Cierre monedero anti vibratorio cromado, cuerpo cromado, Hreg=31-64mm, s/leng	
490412EK	Cierre triangulo anti vibratorio metal negro, cuerpo metal negro, Hreg=31-64mm, s/leng,	

CIERRES ANTIVIBRATORIO, IP65, PERFOR. 20,1mm, FIJ. C/ TUERCA, EMKA – ALEMANIA

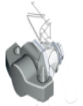

CODIGO	DESCRIPCION	
494023EK	Cierre operado c/botón + llave metal cromado, H=31mm	

CIERRES CON MANILLA TIPO T, IP65, PERFOR. 20,1mm, FIJ. C/ TUERCA, EMKA – ALEMANIA

CODIGO	DESCRIPCION	
493919EK	Cierre manilla T/40mm metal negro , cuerpo poliamida negro, c/lengüeta acero	
490716EK	Cierre manilla T/40mm poliamida negro , cuerpo poliam. negro, H=18mm c/lengüeta acero	
490923EK	Cierre IP 66, manilla T/40mm poliam. negro, cuerpo poliam. c/empaquetadura , GH=18mm c/lengüeta poliamida	
490928EK	Cierre IP66, manilla T/40mm poliam. negro, cuerpo poliam. c/empaquetadura , H=18mm c/leng. acero	
490109EK	Cierre manilla T /78mm cromada sin llave, cuerpo metal cromado, H=18mm c/ lengüeta acero	
494002EK	Cierre manilla T /78mm cromada con llave, cuerpo metal cromado, H=18mm c/ lengüeta acero	
493908EK	Cierre manilla T /78mm (poliamida) sin llave, cuerpo metal negro, H=18mm c/ lengüeta acero	
493909EK	Cierre manilla T /78mm (poliamida) con llave, cuerpo metal negro, H=18mm c/ lengüeta acero	
494012EK	Cierre manilla T /78mm cromada sin llave, cuerpo metal cromado, c/ adaptador H=50mm, c/lengüeta acero	
490208EK	Cierre manilla T /50mm (metal negro), con llave, cuerpo metal negro, H=18mm c/lengüeta acero	
493912EK	Cierre manilla T /50mm (poliamida) sin llave, metal negro, H=18mm c/lengüeta acero	
493913EK	Cierre manilla T /50mm (poliamida) con llave, cuerpo metal negro, H=18mm c/lengüeta acero	
490924EK	Cierre manilla T /50mm (poliamida) sin llave, cuerpo metal negro, H=18mm, lengüeta poliamida	
490925EK	Cierre manilla T /50mm (poliamida) con llave, cuerpo metal negro, H=18mm, lengüeta poliamida	





490414EK	Cierre manilla T /50mm negra anti vibratorio, c/llave, reg. H=45/64mm, s/leng	
490113EK	Cierre manilla tipo T / 50mm metal negro, cuerpo metal, c/portacand H=18mm con lengüeta acero	
493921EK	Cierre y manilla zamak negro tipo T / 50mm c/portacand H=18mm sin lengüeta acero	

CIERRES CON MANILLA TIPO L, IP65, PERFOR. 20,1mm, FIJ. C/ TUERCA, EMKA – ALEMANIA

CODIGO	DESCRIPCION	
490111EK	Cierre manilla tipo L /105mm cromado sin llave, cuerpo metal, H=18mm c/lengüeta acero	
490112EK	Cierre manilla tipo L /105mm cromado con llave, cuerpo metal, H=18mm c/lengüeta acero	
494004EK	Cierre manilla tipo L /105mm cromado, con llave, cuerpo metal, H=18mm, tuerca toma a tierra c/lengüeta acero	
493914EK	Cierre manilla L /105mm poliam. negra sin llave, cuerpo cromado H=18mm c/lengüeta acero	
493915EK	Cierre manilla L /105mm poliam. negra con llave, cuerpo cromado, , H=18mm c/lengüeta acero	
494201EK	Manilla Heavy duty negra sin llave, c/porta cand. Cuerpo metálico, H=26mm, para leng.3ptos (sin leng.)	
4942091EK	Manilla Heavy duty negra con llave, c/porta cand. Cuerpo metálico, H=26mm, para leng.3ptos (sin leng.)	
494202EK	Manilla poliamida negro, Heavy duty, retenedor de lengüeta	

491818EK	Cierre electrónico c/teclado + unid control + 1 cierre c/imán puerta	
491819EK	Cierre electrónico c/teclado + unid control + 2 cierre c/imán puertas	

ACCESORIOS PARA CIERRES, IP65, PERFOR. 20,1mm

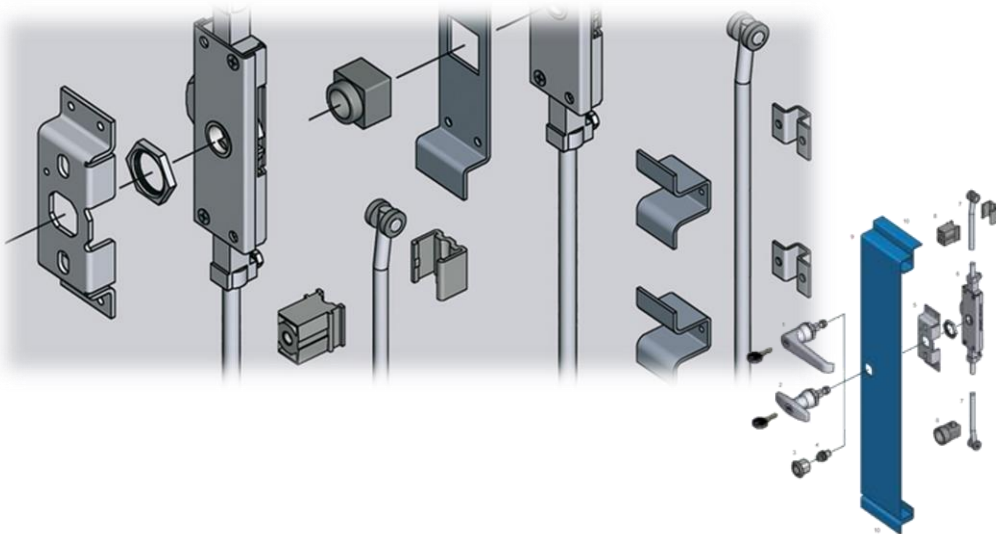

CODIGO	DESCRIPCION	
491218EK	Lengüeta metálica para cierres L=45mm H=18mm (GH=18)	
491220EK	Lengüeta metálica para cierres L=45mm H=20mm (GH=18)	
491222EK	Lengüeta metálica para cierres L=45mm H=22mm (GH=18)	
491225EK	Lengüeta metálica para cierres L=45mm H=25mm (GH=18)	
491228EK	Lengüeta metálica para cierres L=45mm H=28mm (GH=18)	
491230EK	Lengüeta metálica para cierres L=45mm H=30mm (GH=18)	
491234EK	Lengüeta metálica para cierres L=45mm H=34mm (GH=18)	
491240EK	Lengüeta metálica para cierres L=45mm H=40mm (GH=18)	
491250EK	Lengüeta metálica para cierres L=45mm H=50mm (GH=18)	
491018EK	Lengüeta en poliamida 35mm para cierres H=18mm	
491020EK	Lengüeta en poliamida 35mm para cierres H=20mm	
491022EK	Lengüeta en poliamida 35mm para cierres H=22mm	
491025EK	Lengüeta en poliamida 35mm para cierres H=24mm	
491028EK	Lengüeta en poliamida 35mm para cierres H=28mm	
491387EK	Tirador poliamida para cierres estándar perforación 20.1mm	
491388EK	Protector de polietileno IP66, p/sist de cierre	
491302EK	Llave metálica para accionamiento tipo triangulo	
491304EK	Llave zamack para accionamiento tipo universal	
491312EK	llave de Poliamida p/accionamiento de cierre tipo triangulo	
491314EK	Llave de poliamida p/accionamiento de cierre tipo universal	



ESPAÑOLETAS IP65 Y ACCESORIOS

ESPAÑOLETAS IP 65, PERFOR. 20,1mm, EMKA-ALEMANIA

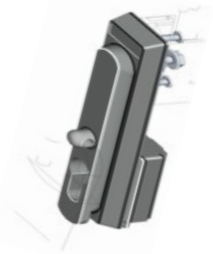
CODIGO	DESCRIPCION	
491814EK	Españoleta manilla L/105mm cromada, derecha, Sin llave, H=26mm, con cuerpo interior	
491815EK	Españoleta manilla L/105mm cromada, derecha, Con llave, H=26mm, con cuerpo interior	
491824EK	Españoleta manilla L/105mm cromada, izquierda, Sin llave, H=26mm, con cuerpo interior	
491825EK	Españoleta manilla L/105mm cromada, izquierda, Con llave, H=26mm, con cuerpo interior	
491812EK	Españoleta manilla T/78mm cromada, derecha, Sin llave, H=26mm, con cuerpo interior	
491813EK	Españoleta manilla T/78mm cromada, derecha, Con llave, H=26mm, con cuerpo interior	
491716EK	Españoleta embutida nylon c/llave, Derecha H=26mm, con cuerpo interior	
491726EK	Españoleta embutida nylon c/llave, izquierda H=26mm, con cuerpo interior	
491736EK	Españoleta manilla embutida zamack negro con llave, H=26mm c/lengüeta 3ptos.	
491826EK	Españoleta Heavy Duty manilla vertical, poliamida negra para varilla Ø14mm	

492022EK	Españoleta poliamida c/llave, portacand, cuerpo acero zincado p/varilla plana,	
494104EK	Españoleta Softline embutida fibra negra c/llave, cuerpo acero zincado p/varilla plana,	

ACCESORIOS PARA ESPAÑOLETAS IP 65, PERFOR. 20,1mm





CODIGO	DESCRIPCION	
491909EK	Varilla redonda acero zincado de 8x1000mm, con roldanas dePVC	
491110EK	Varilla redonda acero zincado de 8x1000mm, con roldanas dePVC	
491907EK	Varilla cuadrada acero zincado 8x1000mm hilo M8	
491908EK	Varilla acero zincado 1100mm Ø14mm p/españoleta 491826EK	
491902EK	Soporte de acero A=26 para guía varilla redonda/cuadrada	
491903EK	Guía en acero zincado para varilla redonda/cuadrada	
492102EK	Varillas planas p/cuerpo de fijación 1121-U125-C gabinete 2m	
492105EK	Guías para varillas planas de españoleta 1125-U184-A	
491103EK	Adaptador para varilla redonda diam. 8mm	
491104EK	Guía nylon para varilla redonda H=20mm	
491105EK	Guía nylon para varilla redonda H=26mm	
		





491118EK	Lengüeta acero zincado 3 puntos L=45mm H=18mm (GH=18)	
491120EK	Lengüeta acero zincado 3 puntos L=45mm H=20mm (GH=18)	
491122EK	Lengüeta acero zincado 3 puntos L=45mm H=22mm (GH=18)	
491126EK	Lengüeta acero zincado 3 puntos L=45mm H=26mm (GH=18)	
491128EK	Lengüeta acero zincado 3 puntos L=45mm H=28mm (GH=18)	
491134EK	Lengüeta acero zincado 3 puntos L=45mm H=34mm (GH=18)	

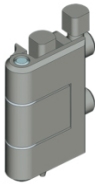

BISAGRAS

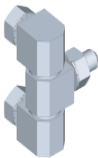
BISAGRAS EMKA-ALEMANIA

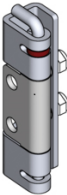
CODIGO	DESCRIPCION	
492460EK	Bisagra externa 60mm poliamida negra, eje acero inox	
4923440EK	Bisagra plana ext. zamack color negra, simetrica 40x40mm perno M6	
4923550EK	Bisagra plana ext. zamack color negra, simetrica 50x50mm perno M6	
4923660EK	Bisagra plana ext. zamack color negra, simetrica 60x60mm perno M8	
4923571EK	Bisagra plana ext. zamack color negra, asimetrica 50x76mm perno M6	
4923441EK	Bisagra plana ext. zamack color negra, simetrica 40x40mm perno embutido M6	
4923551EK	Bisagra plana ext. zamack color negra, simetrica 50x50mm perno embutido M6	
4923661EK	Bisagra plana ext. zamack color negra, simetrica 60x60mm perno embutido M8	
4923572EK	Bisagra plana ext. zamackcolor negra, asimetrica 50x76mm perno embutido M6	
492416EK	Bisagra semiplana zamack.ng.asimetrica (14x69)+(33x60)mm	
492501EK	Bisagra encaje abertura 180° pasador acero galvanizado	
492503EK	Bisagra semi encaje distanc abertura 15mm 180° eje metal	
492506EK	Bisagra encaje c/distanciador 180° pasador acero galvanizado	

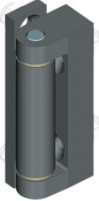
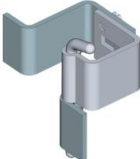
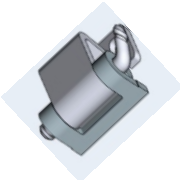



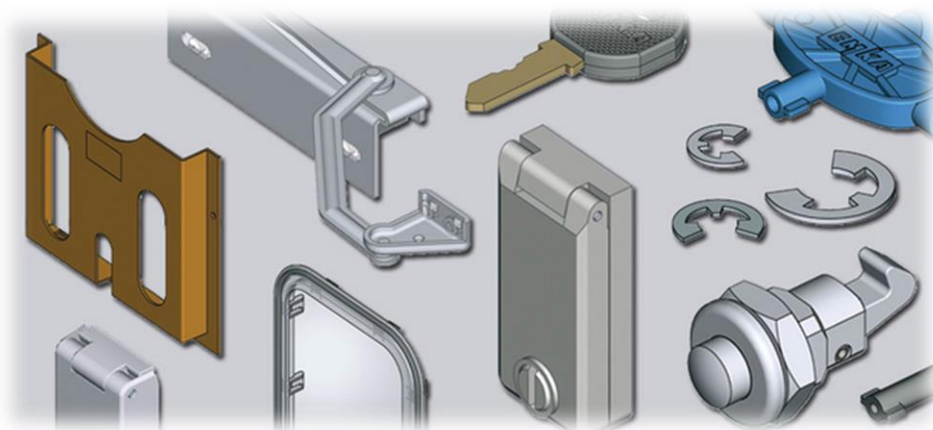

492630EK	Bisagra externa acero galvanizado L=49MM, apernada en 3 secciones, M8	
492631EK 492632EK	Bisagra externa acero galv aper 3sec central L45mm alto40mm Bisagra externa acero galv aper 3sec central L67mm alto55mm	
492633EK	Bisagra soldable con resorte L=53mm	
492634EK	Bisagra embutida para servicio pesado L=90mm	
492801EK	Bisagra externa poliamida negra 95mm apenable	
4936166EK 4936167EK	Bisagra externa cromada 66mm para pestaña de puerta 19.5mm Bisagra externa cromada 66mm p/pestaña puerta 25.5mm	
4937002EK 4937010EK	Bisagra regulable acero zincado reg simple soldable, pestaña 17mm Bisagra Heavy Duty acero zincado reg simple eje fijo	
4937003EK	Bisagra fija+apenable 120° acero zincado L60mm aba20mm	

98100879EK 98100880EK	Bisagra 180° Derecha Bisagra 180° Izquierda	
--------------------------	--	---



ACCESORIOS PARA TABLERO

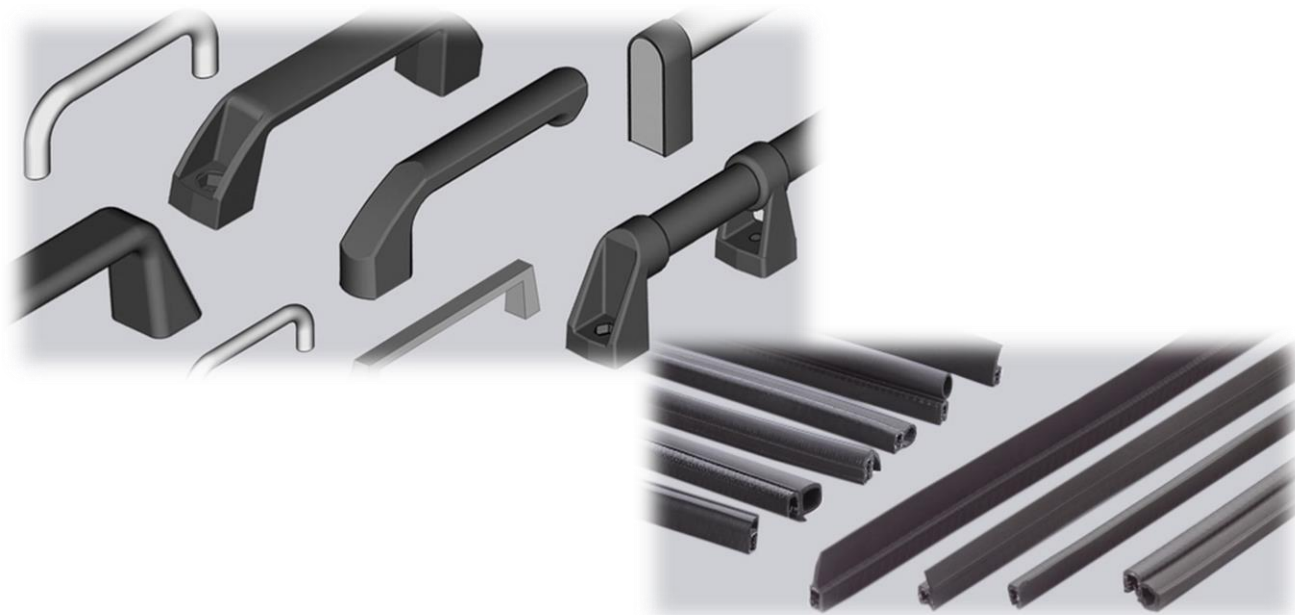

ACCESORIOS PARA TABLEROS EMKA -ALEMANIA

CODIGO	DESCRIPCION	
493101EK	Picaporte atornillable y soldable en acero galvanizado	
493103EK	Picaporte interior liviano p/puertas galvanizado 50x36mm	
493104EK	Picaporte interior p/puertas galvanizado fij. c/tornillos	
493204EK	Soporte telescópico 2 pos. acero galvanizado c/botón traba, 215/360mm	
493208EK	Soporte telescópico 2 pos. acero galvanizado c/botón traba, 377/710mm	
493207EK	Pasa cables poliamida color negro 100x44.5mm Ø6.3mm	
493220EK	Fijador Articulado Der acero niquelado 290mm extendido	
493221EK	Fijador Articulado Izq acero niquelado 290mm extendido	
493304EK	Portaplanos plástico A4 color naranja 236x264x30mm	
493314EK	Portaplanos plástico A4 color gris 236x264x30mm	



MANILLAS, PERFILES Y CINTAS DE GOMAS

MANILLAS EMKA – ALEMANIA

CODIGO	DESCRIPCION	
493401EK	Manilla tipo estribo poliamida negra 122x26x40mm M6	
493402EK	Manilla tipo estribo poliamida negra 150x26x52mm M6	
493403EK	Manilla en zamack cromado 95.5x24mm	
493404EK	Manilla en zamack cromado 81x11x22mm	
493408EK	Manilla de encaje ng 113x67mm perf 100x50mm chapa 1.2-1.6mm	

PERFILES Y CINTAS DE GOMA EMKA - ALEMANIA

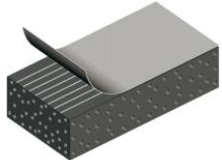
CODIGO	DESCRIPCION	
55011120EK	Cinta autoadhesiva goma ng c/ malla ext 10x20mm (rollo 5m)	
55011130EK	Cinta autoadhesiva goma ng c/ malla ext 10x30mm (rollo 5m)	
55011140EK	Cinta autoadhesiva goma ng c/ malla ext 10x40mm (rollo 5m)	
55011310EK	Cinta autoadhesiva goma ng c/malla ext 3x10mm (rollo 10m)	
55011315EK	Cinta autoadhesiva goma ng c/malla ext 3x15mm (rollo 10m)	
55011320EK	Cinta autoadhesiva goma ng c/ malla ext 3x20mm (rollo 10m)	
55011510EK	Cinta autoadhesiva goma ng c/ malla ext 5x10mm (rollo 10m)	
55011520EK	Cinta autoadhesiva goma ng c/ malla ext 5x20mm (rollo 10m)	
55011530EK	Cinta autoadhesiva goma ng c/ malla ext 5x30mm (rollo 10m)	
55011540EK	Cinta autoadhesiva goma ng c/ malla ext 5x40mm (rollo 10m)	
55011610EK	Cinta autoadhesiva goma ng c/ malla ext 6x10mm (rollo 10m)	
55011615EK	Cinta autoadhesiva goma ng c/ malla ext 6x15mm (rollo 10m)	
55011620EK	Cinta autoadhesiva goma ng c/ malla ext 6x20mm (rollo 10m)	
55011625EK	Cinta autoadhesiva goma ng c/ malla ext 6x25mm (rollo 10m)	
55011630EK	Cinta autoadhesiva goma ng c/ malla ext 6x30mm (rollo 10m)	

5504106EK	Perfil para sellar 10x6mm (alto x ancho) (1m)	
5504154EK	Perfil para ventana 15x4x2mm (1m)	
5504155EK	Filler para perfil 15x4x2mm (1m)	
5504214EK	Perfil para ventana 21x4x2mm (1m)	
5504215EK	Filler para perfil 21x4x2mm (1m)	
5504156EK	Perfil para sellar 15x6mm (alto x ancho) (1m)	
5504162EK	Perfil Z para ventana 16.2x2.4x4.5mm radio min 40mm (1m)	
55041816EK	Perfil de cuatro labios H=18mm A=16mm (1m)	
55042220EK	Perfil de cuatro labios H=22mm A=20mm (1m)	
31050326EK	Visor fijo en macrolon 110x110mm p/puertas espesor 1.5mm	
31050327EK	Visor fijo en macrolon 175x125mm p/puertas espesor 1.5mm	

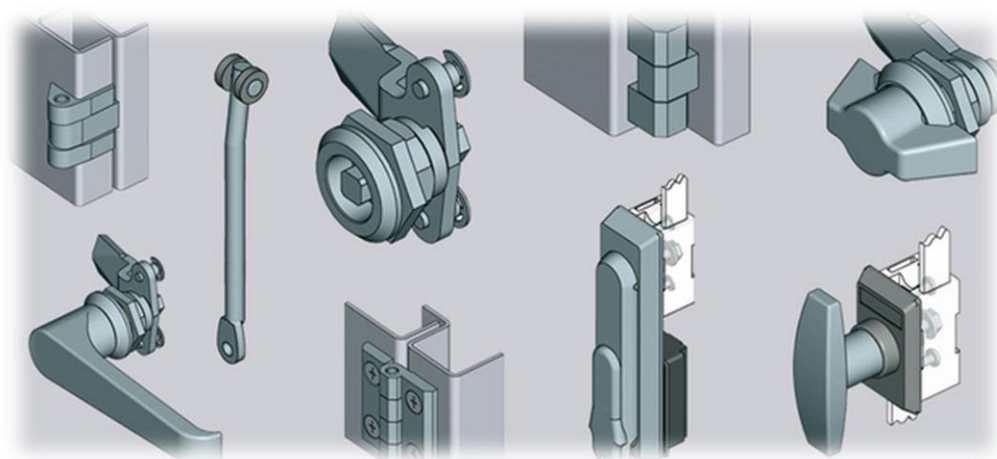

PROGRAMA DE CIERRES, ESPAÑOLETAS Y BISAGRAS DE ACERO INOXIDABLE





CIERRES DE ACERO INOXIDABLE EMKA-ALEMANIA

CODIGO	DESCRIPCION	
492201EK	Mini Cierre acero inox.AISI 303, tipo monedero s/lengüeta GH=18 perf.14,1mm	
492207EK	Mini Cierre acero inox.AISI 303, tipo universal s/lengüeta GH=18 perf.14,1mm	
492206EK	Mini cierre acero inox AISI 303, tipo triangulo s/lengüeta GH=18 perf 14.1mm	
492202EK	Cierre acero inox.AISI 303, tipo triangulo, s /lengüeta, GH=18 perf.20,1mm	
492203EK	Manilla acero inox AISI 316, tipo L/105mm s/llave, s /lengüeta, GH=18 perf.20.1mm	
492204EK	Cierre acero inox AISI 316, tipo T/78mm s/llave, s/lengüeta, GH=18 perf.20.1mm	
492208EK	Cierre Asepticode compresión, industria alimenticia, , IP69K, Inox, AISI 316L, s/lengüeta, GH=43, perf. 20,1mm	
492209EK	Llave zamack para cierre aseptico 492208EK	

ACCESORIOS ACERO INOXIDABLE PARA CIERRES, EMKA-ALEMANIA

CODIGO	DESCRIPCION	
492218EK	Lengüeta acero inoxidable L=45mm, H=18mm	
492220EK	Lengüeta acero inoxidable L=45mm, H=20mm	
492226EK	Lengüeta acero inoxidable 3 puntos L=45mm H=26mm	

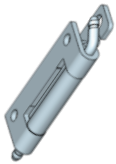
BISAGRAS DE ACERO INOXIDABLE, EMKA-ALEMANIA

CODIGO	DESCRIPCION	
492744EK	Bisagra plana exterior, inoxidable, simétrica 40x40mm p/perno M5	
492755EK	Bisagra plana exterior, inoxidable, simétrica 50x50mm p/perno M6	
492766EK	Bisagra plana exterior, inoxidable, simétrica 60x60mm p/perno M8	
98022853EK	Bisagra plana exterior, inoxidable, simétrica 60x60mm p/perno M8	
492756EK	Bisagra plana exterior, inoxidable, asimétrica 50x63mm p/perno M6	
492635EK	Bisagra derecha 60mm, inox AISI 304 interior con resorte AISE 303	
492636EK	Bisagra izquierda de encaje con resorte en acero inoxidable	
4927005EK	Bisagra inox 304, 60mm, exterior, abert. pta.120°, H=26mm	
492620EK	Bisagra externa acero inox apernada en 2 secciones, M6	
492731EK	Bisagra externa acero inox 40mm apernada en 3 seccion, M6	
492730EK	Bisagra externa acero inox 49mm apernada en 3 seccion, M8	

492732EK	Bisagra semiplana inox asimetrica 14x69 + 33x60 p/perno M6	
492761EK	Bisagra Exterior acero inoxidable 64x17,5mm	
492771EK	Bisagra Exterior acero inoxidable 76x18,5mm	
492505EK	Bisagra encaje cuerpo acero inox AISI 316 c/eje AISI303	

CIERRES EXTERIORES EMKA - ALEMANIA



A PEDIDO